

## Lumistar luminaires USL 15 and USL 35 and -listed types, stainless steel

**USL 15:** for general applications, mounted with hinged bracket  
**USL 35:** special variant for sterile environments with adapter collar for fitting over flanges, etc.

- **For mounting on sight glass fittings:**  
 This sight glass luminaire is designed for universal applications. It is ideal for use in combined sight and light ports (single-flange version) or with two separate ports (2-flange version).
- **Compact design, powerful light output:**  
 Glare-free illumination; suitable for circular sight glass fittings to DIN 28120/DIN 28121 or similar, for screw-type sight glass fittings in compliance with DIN 11851, and for METAGLAS® and BioControl fittings.
- **Application in chemical, pharmaceutical, biogas and food processing industries:**  
 It is ideal for illuminating bioreactors, laboratory mixers and filters as well as the interiors of tanks, agitators, separators, pipelines and other, usually closed, vessels in **non-explosive operating environments**.
- **Protection class:** Dust- and waterjet proof, IP 65 according to EN 60 529 / DIN VDE 0470, Part 1
- **Operating conditions:**  
 Independent of the internal pressure/vacuum in the vessel. Under no circumstances should a sight glass luminaire be used on its own to close a vessel port or as a replacement for the cover flange or instead of the complete sight glass flange assembly.
- **Max. admissible ambient temperature at the cable entry gland with halogen version: 90°C; with LED version: 40°C.**
- **Very easy to install using special mountings, ensuring convenience of use:**  
**USL 15:** The luminaire is attached to the cover flange of the circular sight glass fitting or the visual flow indicator by means of a hinged bracket, or fastened to the grooved nut on screw-type sight glass fittings.  
**USL 35:** The luminaire is placed over an adapter flange and secured.  
**Caution:** Do not look into light – danger of impaired eyesight!

### Lumistar luminaires USL 15 and USL 35 fit the following sizes:

- Circular sight glass fitting acc. to DIN 28120: from DN 40
- Circular sight glass fitting acc. to DIN 28121: from DN 40
- Visual flow indicators: from DN 40
- Screw-type sight glass fittings in line w. DIN 11851: from DN 65

- **Voltage type:** AC/DC  
**Operating voltage:** 12 V, 24 V, 120 V, 230 V  
**Wattage:** up to 100 W, depending on operating voltage

- **Transformers:**  
 Transformers for 12 V or 24 V secondary voltage can be supplied on request.

- **Push-button:**  
**Luminaires with a wattage of 50 W and more should only be operated by push-button (not in continuous mode).**  
 Should an integrated push-button not be included in the order/scope of supply, it is essential for an external momentary-contact

CE

also available  
in LED-technology

3755.239 d



Lumistar luminaire USL 15 with hinged bracket mounting



Lumistar luminaire USL 35 mounted on a BioControl sight glass with sterile technology

push-button or a timer to be installed in the power supply line, outside the luminaire! Under no circumstances should the maximum temperatures specified for the luminaire be exceeded.

- **Mounting parts for USL 15:**  
 The luminaire mounting (hinged bracket) is included in the scope of supply. The flange collar for mounting on screw-type sight glass fittings of DN 65 must be ordered separately.

• Dimensions and electrical data for Lumistar luminaires USL 15 and USL 35 and -listed types

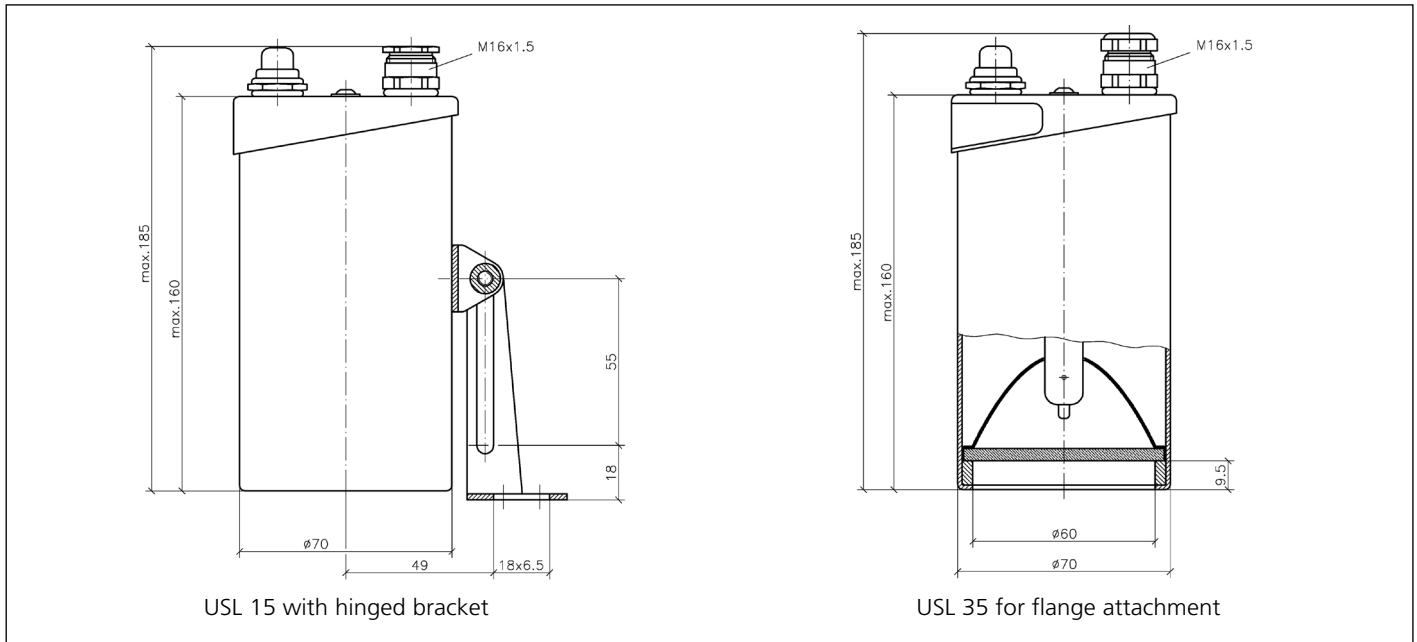

• Components and materials:

- Body and cover: Stainless steel 1.4404
- Mounting parts (hinged bracket and flanged adapter for attachment to screw-type sight glass fitting DN 65): Stainless steel 1.4301

- Power cable: 3 m (3 x 0.75 mm<sup>2</sup>) works fitted
- Weight:  
without integral transformer: 0.85 kg  
with integral transformer: 1.21 kg

• Connecting data:

Item	Type USL 15/35	Nominal voltage V	Push-button	Transformer	Socket	USL 15 Part. No.	USL 35 Part. No.	USL 15-UL Part. No.	USL 35-UL Part. No.
1	(12 V) 20 W	12 ≈	with	without	GY6.35	3540.231.00	3540.365.00	-	-
2	(12 V) 20 W	12 ≈	without	without	GY6.35	3540.232.00	3540.366.00	-	-
3	(24 V) 20 W	24 ≈	with	without	G4	3540.233.00	3540.367.00	3540.445.00	3540.447.00
4	(24 V) 20 W	24 ≈	without	without	G4	3540.234.00	3540.368.00	3540.446.00	3540.448.00
5	(120 V) 20 W	120 ≈	with	without	GY6.35	3540.235.00	3540.372.00	-	-
6	(120 V) 20 W	120 ≈	without	without	GY6.35	3540.236.00	3540.373.00	-	-
7	(230 V/12 V) 20 W	230 ~	with	with	G4	3540.237.00	3540.375.00	-	-
8	(12 V) 50 W	12 ≈	with	without	GY6.35	3540.240.00	3540.369.00	-	-
9	(24 V) 50 W	24 ≈	with	without	GY6.35	3540.242.00	3540.356.00	3540.981.00	3540.983.00
10	(120 V) 50 W	120 ≈	with	without	GY6.35	3540.244.00	3540.351.00	-	-
11	(120 V) 50 W	120 ≈	with	without	BA15d	-	3540.353.00	3540.691.00	3540.693.00
12	(230 V) 50 W	230 ≈	with	without	GZ10	3540.238.00	3540.380.00	-	-
13	(24 V) 100 W	24 ≈	with	without	GY6.35	3540.247.00	3540.357.00	3540.987.00	3540.989.00
14	(120 V) 100 W	120 ≈	with	without	GY6.35	3540.249.00	3540.355.00	-	-
15	(120 V) 100 W	120 ≈	with	without	BA15d	-	3540.354.00	3540.697.00	3540.699.00
<b>LED Versions</b>									
16	(24 V) 4 W	24 ≈	with	converter	GU5.3	3541.429.00	3541.434.00	-	-
17	(230 V) 5 W	230 ~	with	without	GZ10	3541.426.00	3540.437.00	-	-

Further versions on request.

- Accessories (for USL 15 only): Flange adapter DN 65, stainless steel (no hinged bracket required), part no. 1356.010.00

- Order details: e. g. Lumistar luminaire USL 15, 24 V/20 W, with push-button, without transformer, part no. 3540.233.00

All dimensions in mm unless stated otherwise. Subject to change without prior notice. 02.16